

UNPD12009030 piatto doccia/ shower tray

codice
code



Piatto doccia Uniko h3 cm 120 X 90.
Uniko h3 cm 120 X 90 shower tray.

cotone/ cotton

finiture COLORS 1250°/ COLORS 1250° finishing

(Specificare il colore al momento dell'ordine/ Specify the color when ordering)

finiture le malteceramiche/ Le malteceramiche finishing

(Specificare il colore al momento dell'ordine/ Specify the color when ordering)

UNPD12009030CT

UNPD12009030...

UNPD12009030 CT/CE/Cl...

UNPD12009030M...

UNPD12009030 MT/MN/MB/MG

CM 120x90xh3

scatole/box 1

kg 54

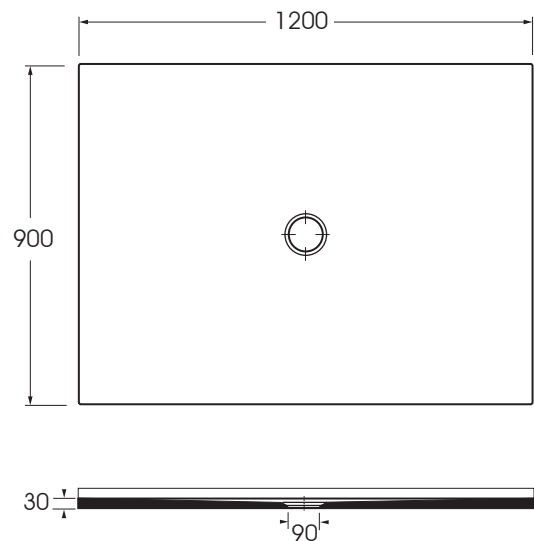

scala/scale 1:20 dimensioni/dimensions in mm

Disponibili per tutti i prodotti UNIKO
e per le pilette con tappo in ceramica PILCE

Available for all UNIKO products
and for the free flow ceramic drains PILCE

COLORS 1250°



le MALTECERAMICHE



Complementi/complements:



Piletta doccia 1" 1/4 di diametro (ø 90)
con tappo in ABS e completa di curva terminale.

1" 1/4 (ø 90) diameter waste system for shower tray
provided with ABS top and terminal bend.

Codice
code

SIF/FRC

Specificare il colore al momento dell'ordine
Specify the color when ordering



Piletta doccia cromo 1" 1/4 di diametro (ø 90)
con tappo in ABS e completa di curva terminale.
1" 1/4 (ø 90) diameter waste system for shower tray
provided with ABS top and terminal bend.

Codice
code

SIF/FR

TECHNICAL SHEET n°: 01	DESIGNER: OFFICINA AZZURRA	CODE: UNPD12009030	Azzurra sanitari in ceramica S.p.a. via Civita Castellana snc 01030 Castel S.Elia (VT) - ITALY Tel.+39.0761 518155 Fax.+39.0761 514560	
SHEET FORMAT: A4	ISO	REVISION: 02	SCALE: 1:20	DATE: 04/10/2019
REGULATIONS: CE EN 14527 / EN33 / Dop-14527 *				
All the measurements respect the tolerances provided by the "AZZURRA QUALITY GUIDELINES".				



* Regulations here shown are exclusively referred to ceramic items